

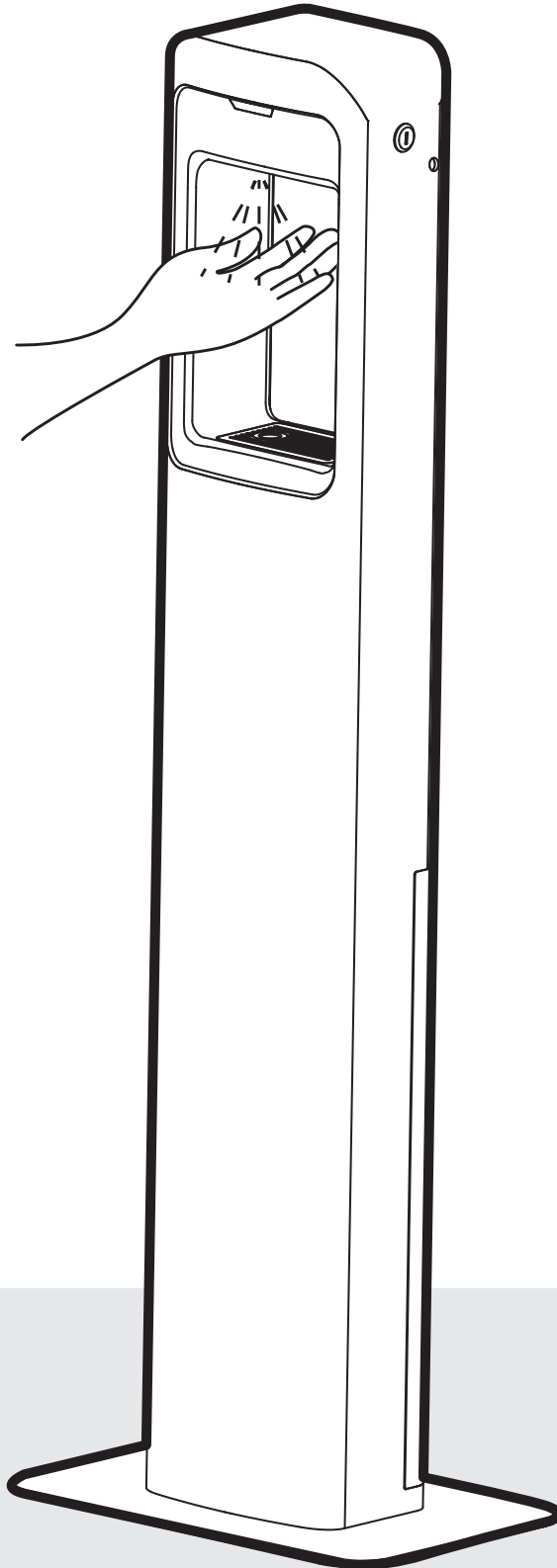

# CAREMEX HYGIENE STATION

## USER MANUAL



Please read user manual carefully before using.

## Specification

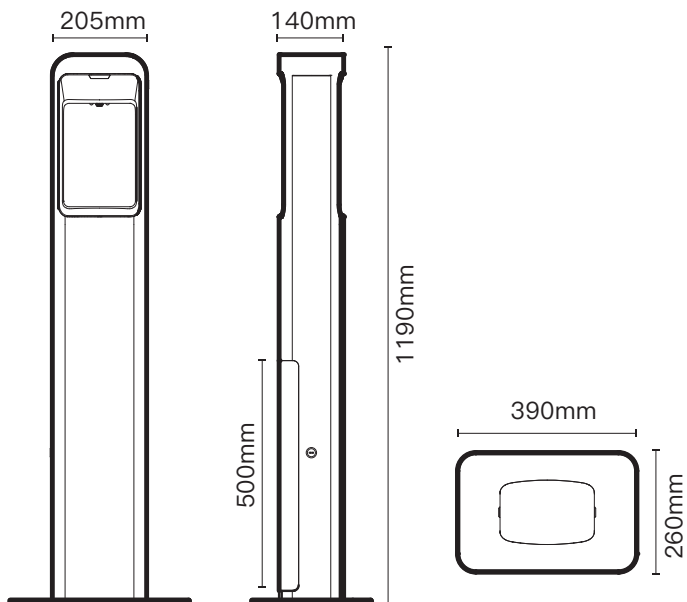

Product Name	Caremex Hygiene Station
Sensor Type	Infrared Sensor
Sensor Range	2~12cm
Material	Aluminum+Iron Sheet Metal+ABS
Capacity	5L
Liquid Output	Spray
Suitable Liquid	Liquid alcoholicity: 75%
Liquid Volume Adjustor	1: 0.3ml      2: 0.6ml
Battery	4 pcs AA alkaline batteries (not included)
Power Adapter	Input Voltage: AC100-240V 50/60Hz Output Voltage: DC6.0V $\geq$ 0.8A

## Parts List

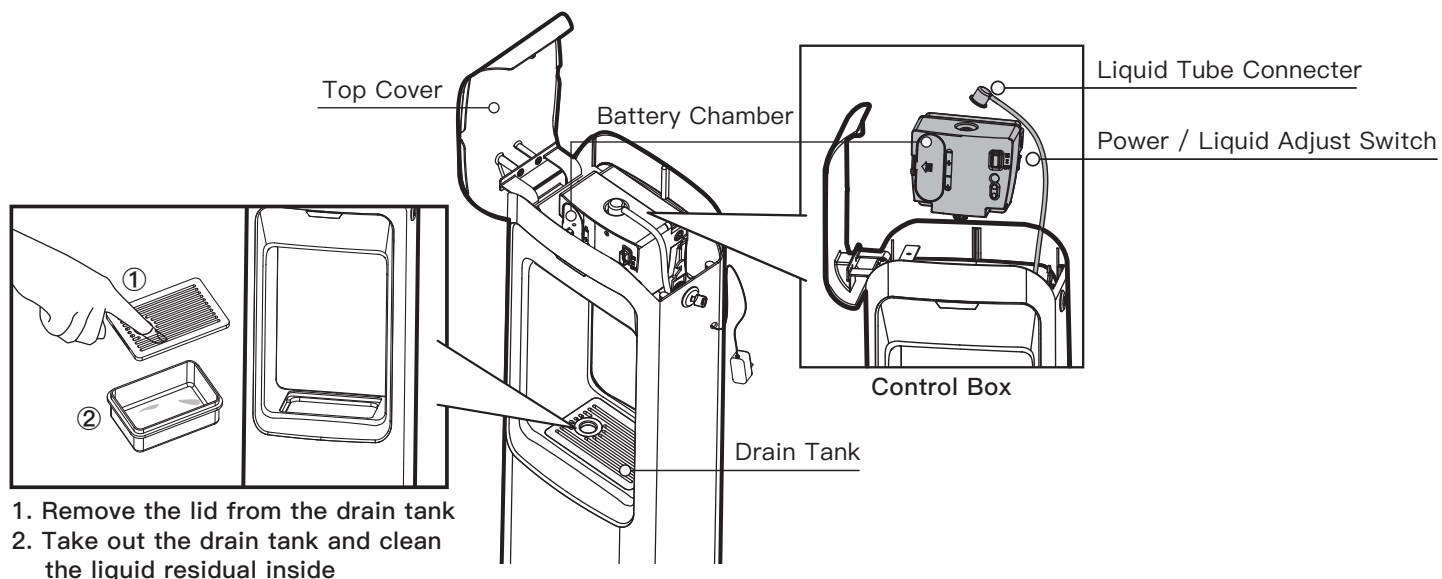
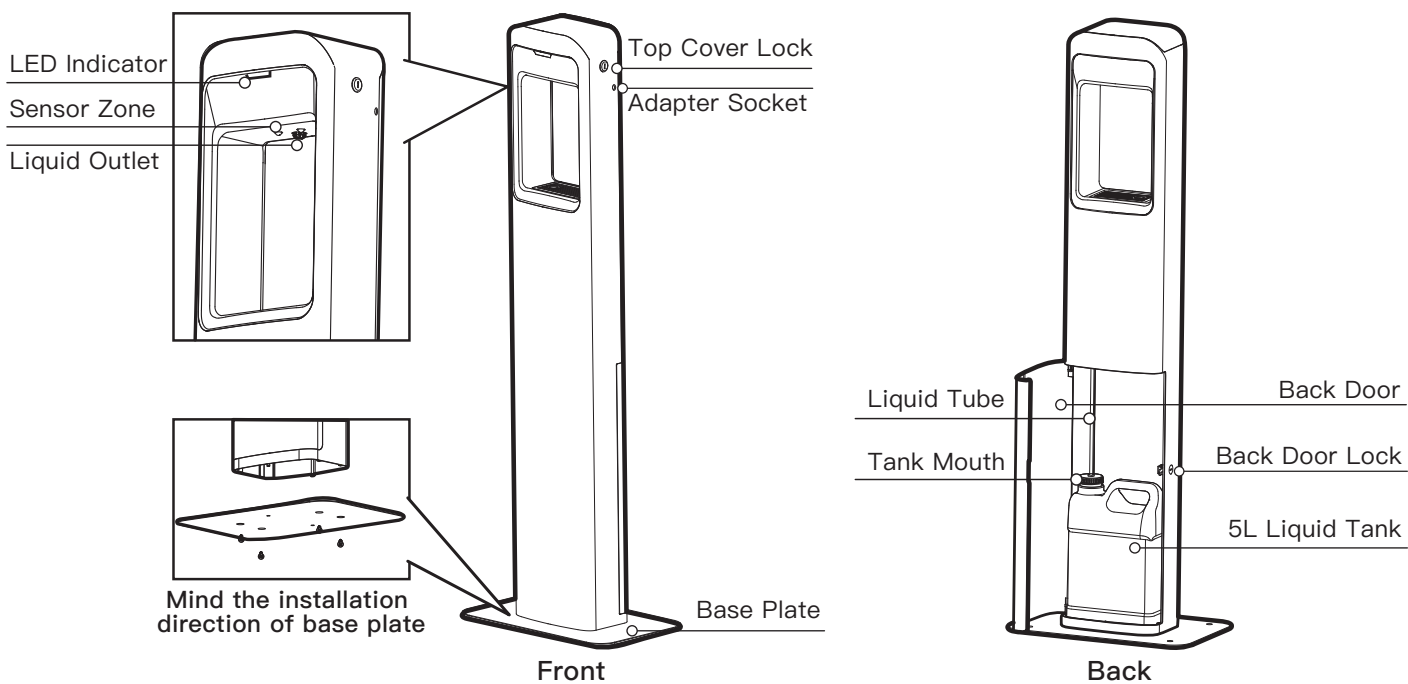

## Installation

- ① Place the product horizontally, put the base plate corresponding to the position of 2 guide posts at the bottom of product.

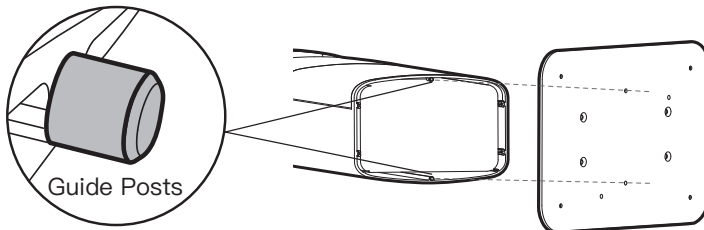

※The side with screw hole concavity should be placed facing outward

- ② Install 4 screws to fixate the base plate onto the product, please mind the installation direction of base plate to make sure an even bottom.

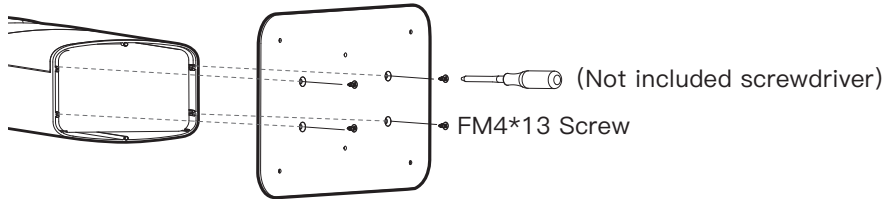

- ③ Move the product to stand.

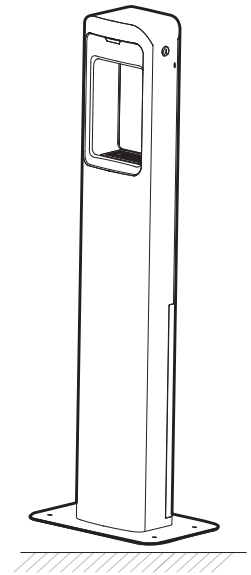

## Pre-Operation

- ① Unlock the back door, unscrew the tank cap to take out the tank for refilling then place it back.

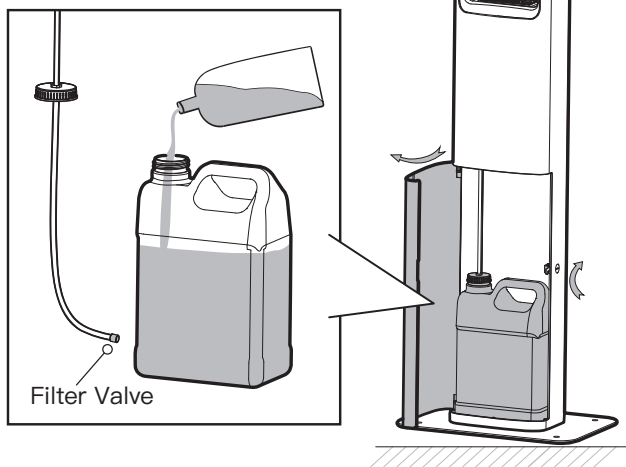

- ② Unlock the top cover to take out the control box for battery loading.

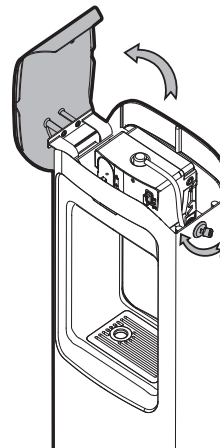

- ③ Unplug the tube then take out the whole control box.

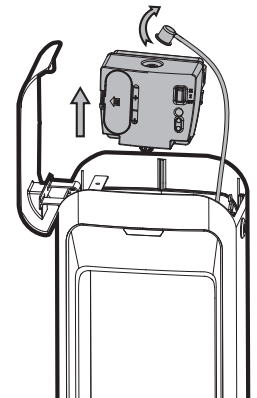

- ④ 1. Open the battery cap by pressing the buckle to the left then insert 4 "AA" batteries according to the right direction.  
2. Connect the DC wire onto the power port on the right side of control box.

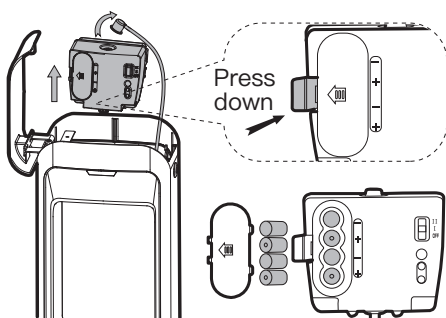

- ⑤ Turn on the power and set the liquid spray volume, there are two setting.  
I small volume: 0.3ml  
II large volume: 0.6ml

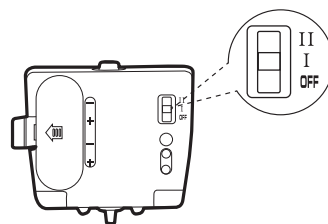

- ⑥ Replace the control box back inside then replug the tube in, please make sure the liquid nozzle is at the right location.

- ⑦ Lock the top cover.

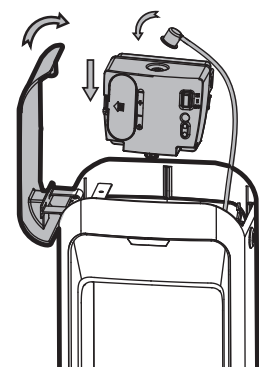

## Ready For Use

Place your hand under the sensor zone to activate the function, first time use you might need to operate it few times to let the air out from the tube.

### LED INDICATION

- When use, LED flash white light.
- When battery is low, LED flash red light to remind battery changing.

### ATTENTION

- ※The drain tank can be taken out for liquid residual clearance.
- ※The sensor has no reaction on dark or black objects.
- ※The key for top cover and back door is the same one.





## Trouble Shooting





Issue	Trouble shooting
No liquid out	a. Check the batteries status; ① If red LED light blinks once every 3 seconds when standby, it indicates the battery voltage is between 3.9V and 4.8V, the product remains functional. ② If red LED light blinks twice when sensor activated, it indicates the battery voltage is lower than 3.9V, the product is out of function.
	b. Check if all parts are installed properly;
	c. Check if the liquid tank is empty and the liquid is compatible with the product type;
	d. Check the motor sound to confirm if the motor works.
	e. Clean spray nozzle.

## Safety Precautions











Ignoring or misunderstanding these signs will result in the following two situations:

 **Attention** This sign indicates “may cause damage to the product”



 **Warning** This sign indicates “may cause personal injury or property damage”

Instruction				
	Prohibited	Mandatory	Do not disassemble without permission	Keep away from fire

### Attention

	Do not expose the unit to direct sunlight to avoid deformation.
	Do not use the product rudely.
	Please take out the batteries and empty the tank when in long-term unused condition.
	Please clean the unit regularly.
	Do not clean the unit with water.
	Do not intentionally break or crash the unit.
	Do not clean the unit with strong corrosive chemical solvent. -Will cause surface damage or deformation.
	Do not let the dust into the liquid tank. -May block the tube and need to replace the liquid and clean the tank.
	Do not disassemble, repair or transform without permission. -Will cause breakdown. Please consult the purchase store or customer service for repair issue.
	Do not fill in corrosive chemicals.
	Keep away from fire.

### Warning

	The product must be securely installed in a stable and reliable place. If the product is not firmly installed, it will cause damage to the body.
	Do not rely on or sit on the product. Otherwise, the product may fall and cause injury.